

10

KNIVES AND TOOLING ACCESSORIES COUTEAUX ET ACCESSOIRES



Table of contents

Table des matières

Reversible knives Plaquette de coupe réversible	373
Reversible knives - Bulldozer, Centrolock Plaquette de coupe réversible - Bulldozer, Centrolock.....	376
Reversible knives - Tersa Plaquette de coupe réversible - Tersa	377
Reversible knives Plaquette de coupe réversible	377
Reversible knives with double radius Plaquette de coupe réversible avec rayon double	378
One-way knife Plaquette de coupe profilée non réversible	378
Triangular spur, chamfering and rounding blades Araseur triangulaire, chanfreineuses et arrondisseurs.....	379
Groovers Rainureuses.....	380
Planing knives Couteaux à raboter.....	381
Back serrated knives Couteaux a dos cranté.....	382
Reversible knives for scraper Plaquette de rechange pour racler	383
Tool for copying lathe Outil pour tour à copier	384
Spacers Bagues intercalaires de réglage	385
Reducing sleeve Manchons de réduction	387
Ball bearing Roulement à billes	390
Template ring Bagues de guidage.....	391
Blade adjustment gauge Calibre réglage des couteaux.....	393
Fixating elements Elements de fixation	394
Clamping keys Clés de fixation.....	395
Clamping wedge Contrefers.....	396
Mounting device and control device Dispositifs de montage et appareil de mesure	396

750/2/3/4 Reversible knives

Plaquette de coupe réversible

Application

Application	
Softwood Bois tendres	HF21
Hardwood Bois durs	HF10
Chipboard, MDF and HDF Aggloméré MDF et HDF	HF02

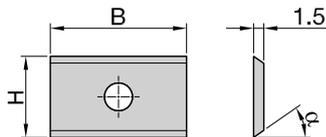

Reversible knife in HW with two cutting edges.
Plaquette réversible de deux coupes en carbure (HW).

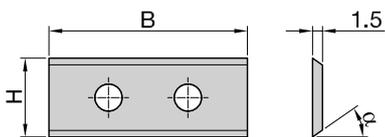

Reversible knife in HW with two cutting edges.
Plaquette réversible de deux coupes en carbure (HW).

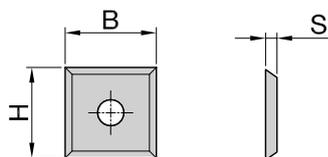

Reversible knife in HW with four cutting edges.
Plaquette réversible de quatre coupes en carbure (HW).

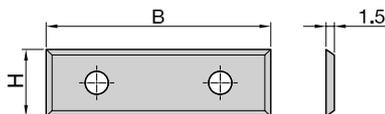

753.350

Reversible knife in HW with four cutting edges.
Plaquette réversible de quatre coupes en carbure (HW).

B	H	S	HF10 $\alpha=35^\circ$	HF21 $\alpha=45^\circ$	HF 02 $\alpha=35^\circ$
7,5	12	1,5	750.097	752.501	
8,6	12	1,5	750.095		
9	12	1,5	750.096		
9,6	12	1,5	750.098	752.502	
10,5	12	1,5	750.200		
11	12	1,5	750.209		
11,6	12	1,5	750.099	752.503	
13	12	1,5	750.202		
14,6	9	1,5	750.090		
14,6	12	1,5	750.201		
15	12	1,5	750.101	752.504	752.099
15,7	12	1,5	750.203		
16	12	1,5	750.206		
17	12	1,5	750.115		
17,6	12	1,5	750.205		
19,6	12	1,5	750.208		
20	12	1,5	750.102	752.505	752.101
21,6	12	1,5	750.204		
24,7	12	1,5	750.103		

B	H	S	HF10 $\alpha=35^\circ$	HF21 $\alpha=45^\circ$	HF02 $\alpha=35^\circ$
24,7	12	1,5	750.117		
30	12	1,5	750.104	752.507	752.102
40	12	1,5	750.105	752.508	
50	12	1,5	750.106	752.509	752.103
60	12	1,5	750.107	752.510	752.191
80	13	2,2	750.108	752.511	
100	13	2,2	750.109		
120	13	2,2	750.110		

B	H	S	HF10 $\alpha=35^\circ$	HF21 $\alpha=45^\circ$	HF02 $\alpha=35^\circ$
12	12	1,5	754.102	754.402	752.100
17	17	2	754.104		
19	19	2	754.105		

B	H	S	HF10 $\alpha=35^\circ$	HF02 $\alpha=35^\circ$
29,5	9	1,5	new 753.204	
	12	1,5	753.207	new 753.217
49,5	9	1,5	new 753.304	
	12	1,5	753.307	new 753.317
50	12	1,7	753.350	



750/2/4/5 Reversible knives

Plaquette de coupe réversible

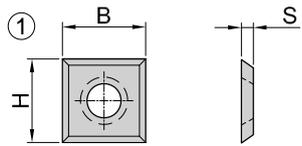

Type	B	H	S	HF10 $\alpha = 35^\circ$	HF21	HF02 $\alpha = 35^\circ$
1	14	14	1,2	750.113		
1		14	1,7	750.112		
1		14	2	750.111		752.111
1	14,3	14,3	2,5	750.116		
2	15	15	2	754.301		
3	15	15	2,5		754.106	
4	21	21	5,5		754.302	

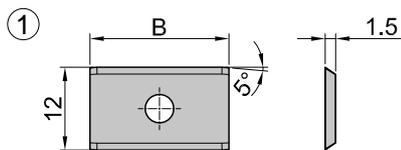
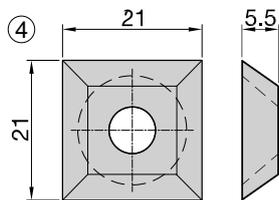
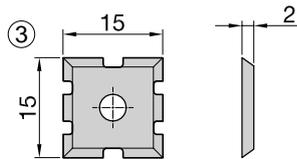
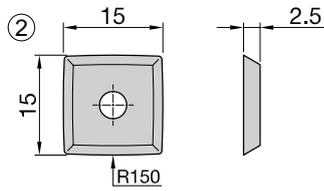

Type	B	H	S	HF10 35°
1	20	12	1,5	755.101
1	24,7	12	1,5	755.102
2	30	12	1,5	755.103
2	50	12	1,5	755.105

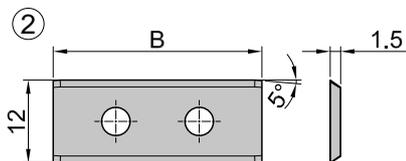

Reversible knife in HW with two cutting edges for article 542 and 574.
Plaquette réversible de deux coupes en carbure (HW) pour 542 y 574.

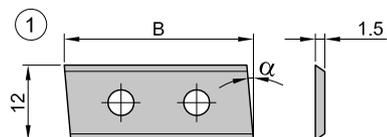

Type	B	H	S	α	HF10 35°
1	20	12	1,5	5°	757.101
1	30	12	1,5	5°	757.102
1	50	12	1,5	5°	757.103
2	20	12	1,5	5°	757.201
2	30	12	1,5	5°	757.202
2	50	12	1,5	5°	757.203
3	29,5	9	1,5	3°	757.500
3	29,5	12	1,5	3°	757.150
3	39,5	12	1,5	5°	757.250
3	49,5	9	1,5	3°	757.501
3	49,5	12	1,5	3°	757.151
3	49,5	12	1,5	5°	757.251

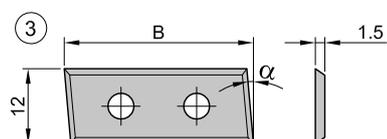
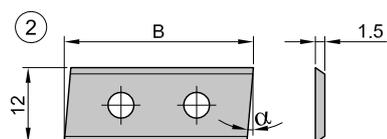

Reversible knives Plaquette de coupe réversible

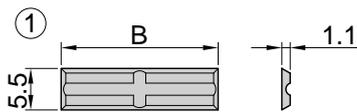

Reversible knife in HW.
Plaquette de coupe réversible en HW.

Type Type	B	H	S	Ref. HW
1	12	5,5	1,1	758.101
1	20	5,5	1,1	758.102
1	30	5,5	1,1	758.103
1	40	5,5	1,1	758.104
1	50	5,5	1,1	758.105
2	12	5,5	1,1	758.301
2	20	5,5	1,1	758.302
2	30	5,5	1,1	758.303
2	40	5,5	1,1	758.304
2	50	5,5	1,1	758.305

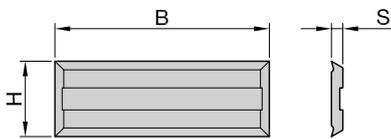

Reversible knife in HC (coated hardmetal)
for article A508.
Plaquette de coupe réversible en HC
(carbure revêtu) pour A508.

B	H	S	Ref. HW
20	5,5	1,1	758.501
20	10	1,5	758.502
30	10	1,5	758.503
50	10	1,5	758.504

759 Reversible knives for portable planers Plaquettes pour rabots électro portatifs

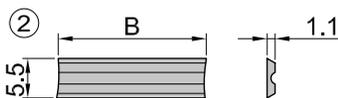
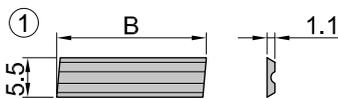

Type Type	B	H	S	Ref. HW
1	56	5,5	1,1	Adler 759.101
1	60	5,5	1,1	Wegoma 759.102
1	75,5	5,5	1,1	AEG, Bosh, Festo, Haffner, Kress, Mafell Metabo, Scheer, Skil, Holz-Her 759.104
1	78	5,5	1,1	Virutex 759.110
new	1	92	5,5	1,1 AEG, Hitachi, Ryobi 759.111
new	1	102	5,5	1,1 AEG 759.112
2	75,7	5,5	1,1	B & Decker 759.105
2	80,5	5,9	1,2	Elu 759.106
2	82	5,5	1,1	AEG, B & Decker, Bosch, ALU, Fein, Haffner, Hitachi, Holz-Her, Mafell, 759.107
2	82,7	5,5	1,1	Makita, Metabo, Peugeot, Ryobi, Skil B & Decker 759.109



794

Reversible knives - Bulldozer Plaquette de coupe réversible - Bulldozer

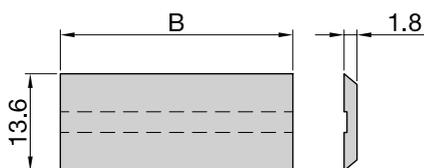

B	H	S	Ref. HW
60	13,6	1,8	794.060.13
70	13,6	1,8	794.070.13
80	13,6	1,8	794.080.13
100	13,6	1,8	794.100.13
110	13,6	1,8	794.110.13
120	13,6	1,8	794.120.13
130	13,6	1,8	794.130.13
140	13,6	1,8	794.140.13
150	13,6	1,8	794.150.13
160	13,6	1,8	794.160.13
180	13,6	1,8	794.180.13
190	13,6	1,8	794.190.13
200	13,6	1,8	794.200.13
220	13,6	1,8	794.220.13
230	13,6	1,8	794.230.13
250	13,6	1,8	794.250.13
260	13,6	1,8	794.260.13

792/3

Reversible knives - Centrolock Plaquette de coupe réversible - Centrolock

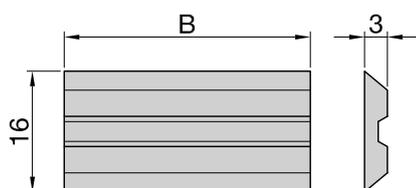

	HS	HW
Softwood Bois tendres	■	□
Hardwood Bois dur		■

■ Recommended - *Recommandée*
□ Partly suitable - *Applicable*

B	H	S	Ref. HS	Ref. HW
20	16	3	793.020.16	792.020.16
60	16	3	793.060.16	792.060.16
80	16	3	793.080.16	792.080.16
100	16	3	793.100.16	792.100.16
130	16	3	793.130.16	792.130.16
150	16	3	793.150.16	792.150.16
170	16	3	793.170.16	792.170.16
180	16	3	793.180.16	792.180.16
210	16	3	793.210.16	792.210.16
230	16	3	793.230.16	792.230.16
240	16	3	793.240.16	792.240.16
260	16	3	793.260.16	792.260.16
270	16	3	793.270.16	792.270.16
310	16	3	793.310.16	792.310.16
460	16	3	793.460.16	792.460.16

796/7 Reversible knives - Tersa

Plaque de coupe réversible - Tersa

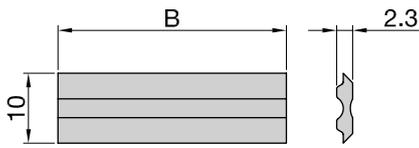

	HS	HW
Softwood Bois tendres	■	□
Hardwood Bois dur		■

■ Recommended - Recommandée

□ Partly suitable - Applicable

B	H	S	Ref. HS	Ref. HW
60	10	2,3	797.060.10	796.060.10
80	10	2,3	797.080.10	796.080.10
100	10	2,3	797.100.10	796.100.10
120	10	2,3	797.120.10	796.120.10
130	10	2,3	797.130.10	796.130.10
150	10	2,3	797.150.10	796.150.10
180	10	2,3	797.180.10	796.180.10
210	10	2,3	797.210.10	796.210.10
230	10	2,3	797.230.10	796.230.10
250	10	2,3	797.250.10	796.250.10
300	10	2,3	797.300.10	796.300.10
310	10	2,3	797.310.10	796.310.10
330	10	2,3	797.330.10	796.330.10
350	10	2,3	797.350.10	796.350.10
400	10	2,3	797.400.10	796.400.10
410	10	2,3	797.410.10	796.410.10
430	10	2,3	797.430.10	796.430.10
450	10	2,3	797.450.10	796.450.10
500	10	2,3	797.500.10	796.500.10
510	10	2,3	797.510.10	796.510.10
530	10	2,3	797.530.10	796.530.10
610	10	2,3	797.610.10	796.610.10
630	10	2,3	797.630.10	796.630.10
640	10	2,3	797.640.10	796.640.10
650	10	2,3	797.650.10	796.650.10

766 Reversible knives

Plaque de coupe réversible

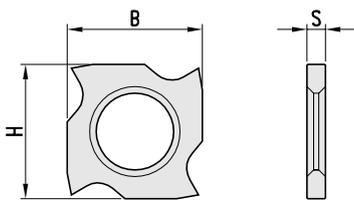

B	H	S	Ref. HW
18	18	1,95	766.101
	18	2,45	766.102
	18	2,95	766.103
new	18	3,70	766.104

Reversible knife in HW for grooving.
Cuchillas reversibles en HW pour rainurage.



761

Reversible knives with double radius Plaquette de coupe réversible avec rayon double

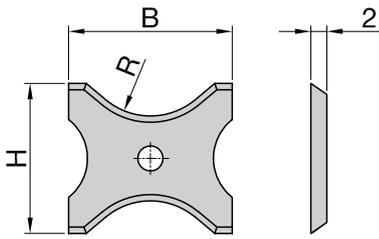

R	B	H	S	Ref. HW
2	13	16	2	761.101
3	13	16	2	761.102
4	13	16	2	761.103
5	20	21	2	761.104
6	20	21	2	761.105
7	20	21	2	761.106
8	20	21	2	761.107
9	26	24	2	761.108
10	26	24	2	761.109
11	26	24	2	761.110
12	26	24	2	761.111
13	26	24	2	761.112
14	30	25	2	761.113
15	30	25	2	761.114
16	30	25	2	761.115

765

One-way knife Plaquette de coupe profilée non réversible

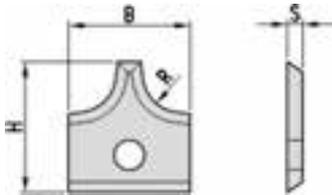

R	B	H	S	Ref. HW
2	16	17,5	2	765.101
3	16	17,5	2	765.102
4	16	17,5	2	765.103
5	16	17,5	2	765.104
6	16	17,5	2	765.105
8	25	25	2	765.107
10	25	25	2	765.109

One-way knife in HW for article 556, 557 and 524.

Plaquette de coupe profilée en HW pour article 556, 557 et 524.

760

Triangular spur Araseur triangulaire

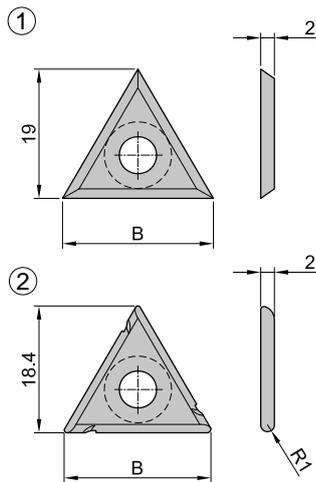

Type	B	H	S	R	Ref. HW
1	22	19	2		760.101
2	22	18,4	2	1	RH 760.201
2	22	18,4	2	1	LH 760.202

780

Chanfering and rounding blades Chanfreineuses et arrondisseurs

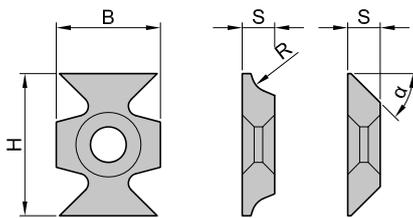

Chanfering and rounding blades in HW for tools with mechanical feed (MEC).

Chanfreineuse et arrondisseur en HW pour outils avec avance mécanisée (MEC).

R	B	H	S	Ref. HW
1,5	16	22	5	780.205
2	16	22	5	780.207
2,5	16	22	5	780.208
3	16	22	5	780.206
4	16	22	5	780.209
5	16	22	5	780.210

α	B	H	S	Ref. HW
45°	16	22	5	780.103

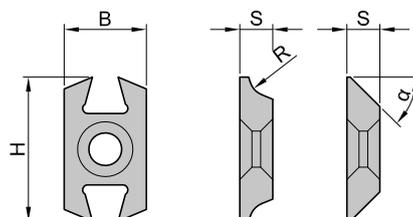

Chanfering and rounding blades in HW for tools with manual feed (MAN).

Chanfreineuse et arrondisseur en HW outils avec avance manuelle (MAN).

R	B	H	S	Ref. HW
2	16	29	5	780.250
3	16	29	5	780.251

α	B	H	S	Ref. HW
45°	16	29	5	780.260



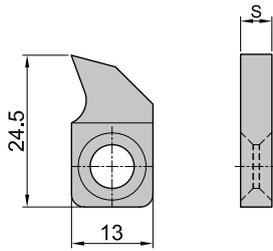

B	H	S	Ref. HW
13	24,5	3	783.100
	24,5	4	783.101
	24,5	5	783.102
	24,5	6	783.103
	24,5	7	783.104

Groove in solid HW for tools with mechanical feed (MEC).

Rainureuse en HW pour outils avec avance mécanisée (MEC).

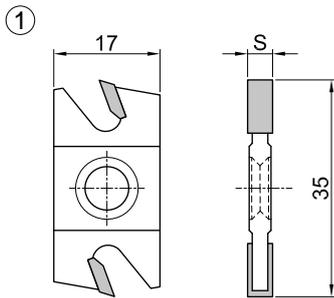

Type	B	H	S	Ref. HW
1	17	35	3	783.109
1		35	4	783.120
1		35	5	783.121
1		35	6	783.122
2	17	24		LH 783.125
2		24		RH 783.126

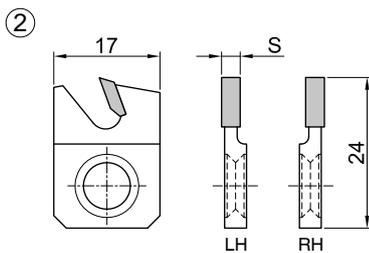

Groove in HW for tools with manual feed (MAN).

Rainureuse en HW pour outils avec avance manuelle (MAN).

771/3 Planing knives Couteaux à raboter

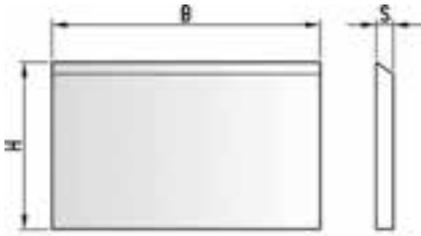

HS knife - Couteaux HS

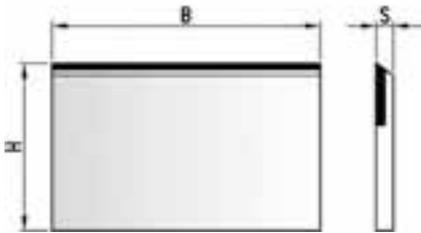

Tipped knife - HW rapporté

	HS	HSP	HW
Softwood Bois tendres	■	■	□
Hardwood Bois dur		■	■

■ Recommended - Recommandé

□ Partly suitable - Applicable

The **HS-Premium** knives are superficial coated with a special substrate material, ensuring outstanding surface finishes quality and extended cutting edge life time. Especially suitable for working glued soft solid woods.

Advantages

- Service life up to 5 times higher than HSS;
- Productivity increase;
- Reduction of sharpening costs;
- Guarantee of excellent finishing quality, with reduction or even elimination of the need for subsequent sanding;
- Easier to sharpen compared to HW blades.

Les couteaux **HS-Premium** sont revêtus superficiellement d'un matériau de support spécial, garantissant une qualité de surface exceptionnelle et une durée de vie prolongée. Particulièrement adapté pour travailler les bois pleins souples collés.

Avantages

- Durée de vie jusqu'à 5 fois supérieure à celle du HSS.
- Productivité accrue.
- Réduction des coûts d'affûtage.
- Garantie d'une excellente qualité de finition, avec réduction ou même élimination du besoin de ponçage ultérieur.
- Plus facile d'affûtage par rapport aux lames HW.

B	H	S	Ref. HS-Premium	Ref. HS18%	Ref. HW
120	25	3		771.120.25	773.120.25
130	25	3		771.130.25	773.130.25
150	25	3		771.150.25	773.150.25
180	25	3		771.180.25	773.180.25
200	25	3		771.200.25	773.200.25
250	25	3		771.250.25	773.250.25
260	25	3		771.260.25	773.260.25
310	25	3		771.310.25	773.310.25
350	25	3		771.350.25	773.350.25
80	30	3	new	771.080.31	773.080.30
100	30	3	new	771.100.31	773.100.30
120	30	3	new	771.120.31	773.120.30
130	30	3	new	771.130.31	773.130.30
150	30	3	new	771.150.31	773.150.30
170	30	3	new	771.170.31	773.170.30
180	30	3	new	771.180.31	773.180.30
200	30	3	new	771.200.31	773.200.30
220	30	3	new	771.220.31	773.220.30
230	30	3	new	771.230.31	773.230.30
240	30	3	new	771.240.31	773.240.30
250	30	3	new	771.250.31	773.250.30
260	30	3	new	771.260.31	773.260.30
300	30	3	new	771.310.31	773.300.30
350	30	3	new	771.350.31	773.350.30
400	30	3	new	771.400.31	773.400.30
410	30	3	new	771.410.31	773.410.30
450	30	3	new	771.450.31	773.450.30
500	30	3	new	771.500.31	773.500.30
510	30	3	new	771.510.31	773.510.30
530	30	3	new	771.530.31	773.530.30
600	30	3	new	771.600.31	773.600.30
610	30	3	new	771.610.31	773.610.30
630	30	3	new	771.630.31	773.630.30
640	30	3		771.640.30	773.640.30
350	35	3	new	771.350.36	773.350.35
400	35	3	new	771.400.36	773.400.35
410	35	3	new	771.410.36	773.410.35
460	35	3	new	771.460.36	773.460.35
500	35	3	new	771.500.36	773.500.35
510	35	3	new	771.510.36	773.510.35
520	35	3	new	771.520.36	773.520.35
530	35	3	new	771.530.36	773.530.35
600	35	3	new	771.600.36	773.600.35
610	35	3	new	771.610.36	773.610.35
630	35	3	new	771.630.36	773.630.35

B	H	S	Ref. HS	Ref. HW
78	25	3,2	Virutex	773.078.25
82	29	3	Makita	773.082.29



774/787 Back serrated knives

Couteaux a dos cranté

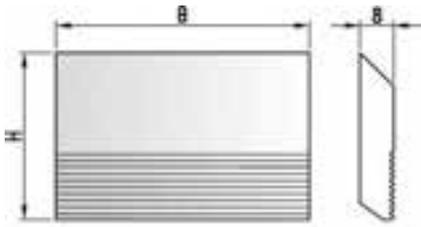

HS knife - Couteaux HS

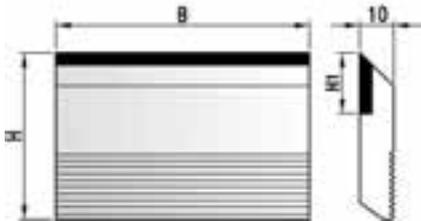

Tipped knife - HW rapporté

	HS	HSP	HW
Softwood Bois tendres	■	■	□
Hardwood Bois dur		■	■

■ Recommended - Recommandé
□ Partly suitable - Applicable

The **HS-Premium** knives are superficially coated with a special substrate material, ensuring outstanding surface finishes quality and extended cutting edge life time. Especially suitable for working glued soft solid woods.

Advantages

- Service life up to 5 times higher than HSS;
- Productivity increase;
- Reduction of sharpening costs;
- Guarantee of excellent finishing quality, with reduction or even elimination of the need for subsequent sanding;
- Easier to sharpen compared to HW blades.

Les couteaux **HS-Premium** sont revêtus superficiellement d'un matériau de support spécial, garantissant une qualité de surface exceptionnelle et une durée de vie prolongée. Particulièrement adapté pour travailler les bois pleins souples collés.

Avantages

- Durée de vie jusqu'à 5 fois supérieure à celle du HSS.
- Productivité accrue.
- Réduction des coûts d'affûtage.
- Garantie d'une excellente qualité de finition, avec réduction ou même élimination du besoin de ponçage ultérieur.
- Plus facile d'affûtage par rapport aux lames HW.

B	H	H1	Ref. HS-Premium	Ref. HS	Ref. HW
40	50	20	new 774.040.51	774.040.50	787.040.50
60	50	20	new 774.060.51	774.060.50	787.060.50
80	50	20	new 774.080.51	774.080.50	787.080.50
100	50	20	new 774.100.51	774.100.50	787.100.50
130	50	20	new 774.130.51	774.130.50	787.130.50
150	50	20	new 774.150.51	774.150.50	787.150.50
180	50	20	new 774.180.51	774.180.50	787.180.50
230	50	20	new 774.230.51	774.230.50	787.230.50
635	50	20	new 774.635.51		787.635.50
650	50	20		774.650.50	
40	60	25	new 774.040.61	774.040.60	787.040.60
60	60	25	new 774.060.61	774.060.60	787.060.60
80	60	25	new 774.080.61	774.080.60	787.080.60
100	60	25	new 774.100.61	774.100.60	787.100.60
130	60	25	new 774.130.61	774.130.60	787.130.60
150	60	25	new 774.150.61	774.150.60	787.150.60
180	60	25	new 774.180.61	774.180.60	787.180.60
230	60	25	new 774.230.61	774.230.60	787.230.60
635	60	25	new 774.635.61		787.635.60
650	60	25		774.650.60	
40	70	30	new 774.040.71	774.040.70	787.040.70
60	70	30	new 774.060.71	774.060.70	787.060.70
80	70	30	new 774.080.71	774.080.70	787.080.70
100	70	30	new 774.100.71	774.100.70	787.100.70
130	70	30	new 774.130.71	774.130.70	787.130.70
150	70	30	new 774.150.71	774.150.70	787.150.70
180	70	30	new 774.180.71	774.180.70	787.180.70
230	70	30	new 774.230.71	774.230.70	787.230.70
635	70	30	new 774.635.71		787.635.70
650	70	30		774.650.70	

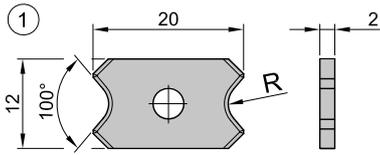

Type	R	B	H	S	Machine	Ref. HW
1	1	12	20	2	Homag, Holz-Her, Reich, SCM	798.101
1	2	12	20	2	Homag, Holz-Her, Reich, SCM	798.102
1	3	12	20	2	Homag, Holz-Her, Reich, SCM	798.103
1	4	12	20	2	Homag, Holz-Her, Reich, SCM	798.104
1	5	12	20	2	Homag, Holz-Her, Reich, SCM	798.105

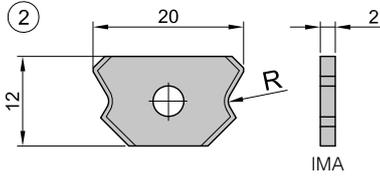

Type	R	B	H	S	Machine	Ref. HW
new 2	1	12	20	2	IMA	798.201
new 2	1,5	12	20	2	IMA	798.202
new 2	2	12	20	2	IMA	798.203

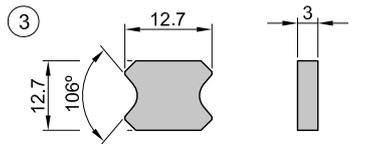

Type	R	B	H	S	Ref. HW
new 3	1	12,7	12,7	3	798.301
new 3	1,5	12,7	12,7	3	798.302
new 3	2	12,7	12,7	3	798.303
new 3	3	12,7	12,7	3	798.304

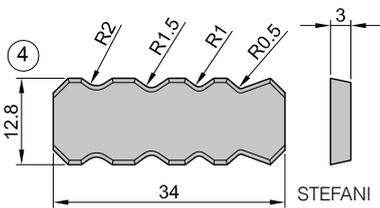

Type	B	H	S	Machine	Ref. HW
new 4	34	12,8	3	Stefani	798.401

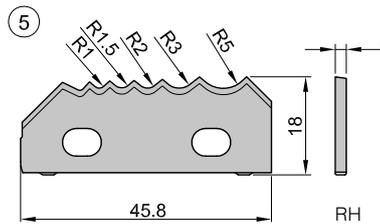

Type	B	H	S	Machine	Ref. LH HW	Ref. RH HW
new 5	45,8	18	2	Homag	798.501	798.502

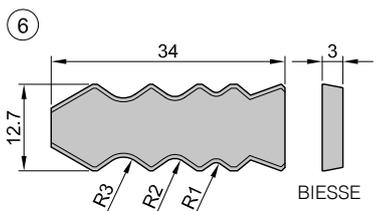

Type	B	H	S	Ref. HW
new 6	34	12,7	3	798.601

Type	B	H	S	Machine	Ref. HW
new 7	14	14	2	Holz-Her	798.701

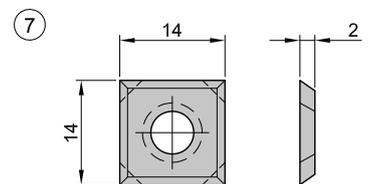

A602

Scraper for edge-banding machines

Racle pour machine à border



	D	LT	Machine Machine	Ref.
new	16x15	117	HOLZ-HER	A602.016.117.01 ■
new	16x15	133	SCM	A602.016.133.01 ■

■ For knives 798, type 1 - Pour plaquette 798, type 1

Tool for copying lathe in HS.
Outil pour tour à copier en HS.

A600

Tool for copying lathe

Outil pour tour à copier

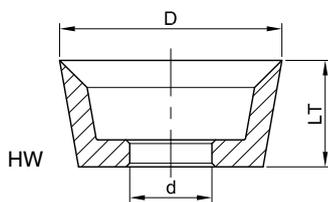
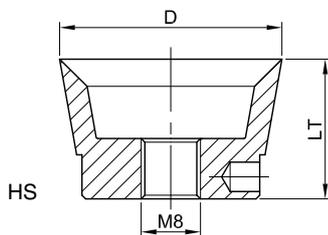

	D	LT	Ref. HS
	22	15	A600.022.015.40
	30	19	A600.030.019.40
	35	20	A600.035.020.40
	45	26	A600.045.026.40
	50	26	A600.050.026.40

	D	LT	d	Ref. HW
new	29	17	14	A600.029.017.14
new	33	17	14	A600.033.017.14
new	36,5	17	16	A600.036.017.16

A650/1

Tool for copying lathe

Outil pour tour à copier

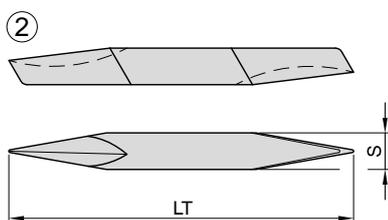
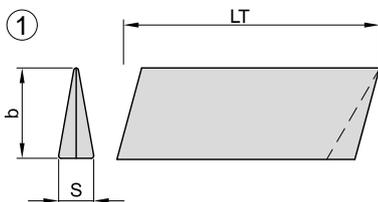

Type Type	b	s	LT	Ref. HS	Ref. HW	Ref. ST
1	23	9,5	100	A650.600.025.00	A650.600.225.00	A650.600.125.00
1	38	15	110	A650.800.040.00	A650.800.240.00	A650.800.140.00

Type Type	S	LT	Ref. HS
2	16	150	A651.600.016.00
2	20	200	A651.800.020.00

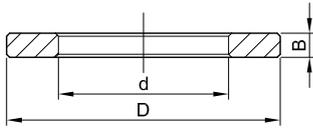

d	B	D	Ref.
30	0,1	50	703.301
	0,2	50	703.302
	0,5	50	703.303
	1	50	703.304
	2	50	703.305
	5	50	703.308
	7	50	703.310
	10	50	703.313
31,75	0,1	50	703.325
	0,2	50	703.326
	0,5	50	703.327
	1	50	703.328
	2	50	703.329
	5	50	703.332
	7	50	703.334
	10	50	703.337
35	0,1	55	703.351
	0,2	55	703.352
	0,5	55	703.353
	1	55	703.354
	2	55	703.355
	5	55	703.358
	7	55	703.360
	10	55	703.363
40	0,1	60	703.400
	0,2	60	703.401
	0,5	60	703.402
	1	60	703.403
	2	60	703.404
	5	60	703.407
	7	60	703.409
	10	60	703.412
45	0,1	65	703.500
	0,2	65	703.501
	0,5	65	703.502
	1	65	703.503
	2	65	703.504
	5	65	703.507
	7	65	703.509
	10	65	703.512
50	0,1	70	703.600
	0,2	70	703.601
	0,5	70	703.602
	1	70	703.603
	2	70	703.604
	5	70	703.607
	7	70	703.609
	10	70	703.612
60	0,1	80	703.851
	0,2	80	703.852
	0,5	80	703.853
	1	80	703.860
	2	80	703.861
	5	80	703.863
	7	80	703.864
	10	80	703.865



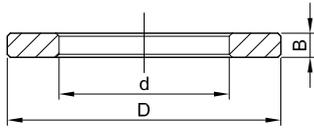

d	B	D	TK	Ref.
20	0,1	45	4/6/32	703.730
	0,2	45		703.731
	0,5	45		703.732
	1	45		703.733
	2	45		703.734
	5	45		703.735
	7	45		703.736
	10	45		703.737
30/35	0,1	65	4/7/48	703.630
	0,2	65		703.631
	0,5	65		703.632
	1	65		703.633
	2	65		703.634
	5	65		703.635
	7	65		703.636
	10	65		703.637
40/50	0,1	80	4/7/65	703.640
	0,2	80		703.641
	0,5	80		703.642
	1	80		703.643
	2	80		703.644
	5	80		703.645
	7	80		703.646
	10	80		703.647
40	0,1	85	4/7/58	A423 - HSK 85WE 703.670
	0,2	85		A423 - HSK 85WE 703.671
	0,5	85		A423 - HSK 85WE 703.672
	1	85		A423 - HSK 85WE 703.673
	2	85		A423 - HSK 85WE 703.674
	5	85		A423 - HSK 85WE 703.675
	10	85		A423 - HSK 85WE 703.676
	20	85		A423 - HSK 85WE 703.677
60	0,1	90	3/7/75	703.880
	0,2	90		703.881
	0,5	90		703.883
	1	90		703.884
	3	90		703.885
	5	90		703.888
	10	90		703.889
	15	90		703.890
20	90		703.891	

new

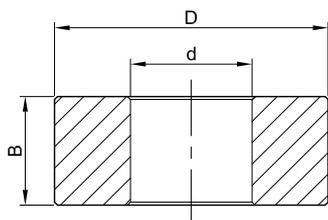

D	B	d	Ref.
35	2	30	714.101
	5	30	714.102
	10	30	714.103
	15	30	714.104
	20	30	714.105
	30	30	714.106
	40	30	714.107
	50	30	714.108
40	2	30	714.251
	5	30	714.252
	10	30	714.253
	15	30	714.254
	20	30	714.255
	30	30	714.256
	40	30	714.257
	50	30	714.258
40	2	31,75	714.151
	5	31,75	714.152
	10	31,75	714.153
	15	31,75	714.154
	20	31,75	714.155
	30	31,75	714.156
	40	31,75	714.157
	50	31,75	714.158
40	2	35	714.201
	5	35	714.202
	10	35	714.203
	15	35	714.204
	20	35	714.205
	30	35	714.206
	40	35	714.207
	50	35	714.208
45	2	30	714.301
	5	30	714.302
	10	30	714.303
	15	30	714.304
	20	30	714.305
	30	30	714.306
	40	30	714.307
	50	30	714.308

Continued next page - Suite page suivante



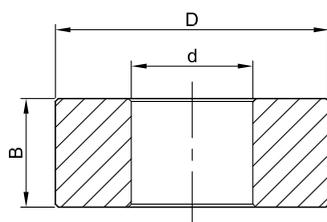

D	B	d	Ref.
50	2	30	714.451
	5	30	714.452
	10	30	714.453
	15	30	714.454
	20	30	714.455
	30	30	714.456
	40	30	714.457
	50	30	714.458
50	2	35	714.401
	5	35	714.402
	10	35	714.403
	15	35	714.404
	20	35	714.405
	30	35	714.406
	40	35	714.407
	50	35	714.408
50	2	40	714.351
	5	40	714.352
	10	40	714.353
	15	40	714.354
	20	40	714.355
	30	40	714.356
	40	40	714.357
	50	40	714.358
50	2	45	714.501
	5	45	714.502
	10	45	714.503
	15	45	714.504
	20	45	714.505
	30	45	714.506

713

Reducing sleeve with collar Manchons de réduction avec épaulement

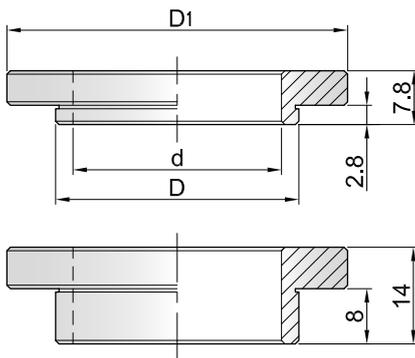

d	D	D1	Ref. 7,8 mm	Ref. 14 mm
30	35	49	713.101	713.115
	40	54	713.102	713.116
	45	59	713.103	713.117
	50	64	713.104	713.118
31,75	35	49	713.105	713.119
	40	54	713.106	713.120
	45	59	713.107	713.121
	50	64	713.108	713.122
35	40	54	713.109	713.123
	45	59	713.110	713.124
	50	64	713.111	713.125
40	45	50	713.112	713.126
	50	64	713.113	713.127
45	50	64	713.114	713.128

Set of 2 reducing sleeves.
Jeux de 2 manchons de réduction.

712

Reducing rings for saw blades Bagues de réduction pour lames de scies circulaires

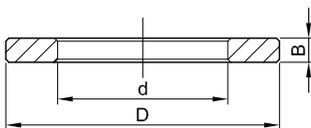

d	B	D	Ref.
16	2	30	712.113.16
new 20	2	22	712.119.20
	2	25	712.114.20
	2	30	712.112.20
	2	32	712.110.20
	2	35	712.106.20
25	2	30	712.111.25
	2	32	712.109.25
	2	35	712.105.25
25,4	2	30	712.118.26
	2	35	712.108.26
30	2	32	712.107.30
	2	35	712.104.30
32	2	35	712.103.32
	2	40	712.102.32
35	2	40	712.101.35



715

Set of bush for the spindle end Jeux de bagues pour montage en bout d'arbre

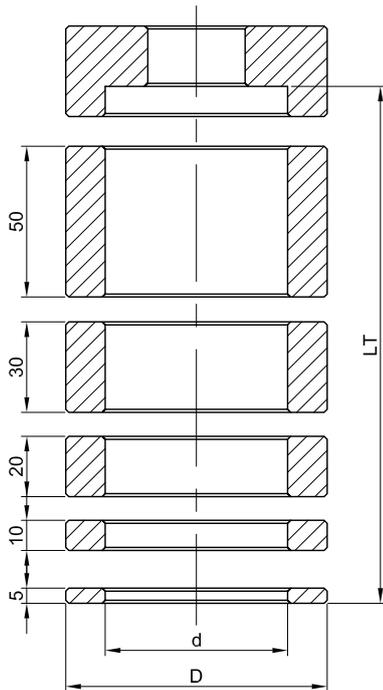

d	D	LT	Ref.
30	43	200	715.300
35	48	200	715.350
40	54	200	715.400
45	62	245	715.450
50	65	245	715.500

Spacer set - Composition du jeu de bagues

	L
2x5; 2x10; 3x20; 2x30; 1x50	200
3x5; 2x10; 1x20; 3x30; 2x50	245

701

Ball bearing Roulement à billes



D	d	Ref.
9,5	3,1	701.051
9,5	4,7	701.052
12,7	4,7	701.053
19	6	701.054
22	8	701.055
55	30	701.101
62	35	701.102
68	40	701.103
75	45	701.104
80	50	701.105
69,85	31,75	701.106

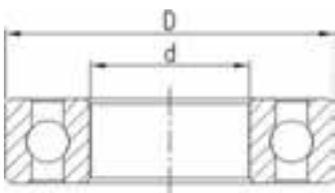

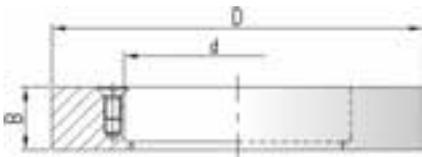

Template ring with ball bearing
 (Ref. 702+701)

Bague de guidage avec roulement à billes
 (Ref. 702+701)

d	B	D	Ref.
55	15,5	70	702.101
	15,5	75	702.106
	15,5	80	702.105
	15,5	85	702.107
	15,5	86	702.104
	15,5	90	702.108
	15,5	94	702.102
	15,5	95	702.109
	15,5	100	702.110
	15,5	105	702.111
	15,5	110	702.112
	15,5	115	702.113
	15,5	120	702.103
	15,5	125	702.115
	15,5	130	702.116
	15,5	135	702.117
	15,5	140	702.118
62	16,5	75	702.145
	16,5	78	702.146
	16,5	80	702.147
	16,5	85	702.148
	16,5	90	702.149
	16,5	95	702.150
	16,5	100	702.151
	16,5	105	702.152
	16,5	110	702.153
	16,5	115	702.154
	16,5	120	702.155
	16,5	125	702.156
	16,5	130	702.157
	16,5	135	702.158
	16,5	140	702.159
68	17,5	75	702.170
	17,5	80	702.171
	17,5	85	702.172
	17,5	90	702.173
	17,5	95	702.174
	17,5	100	702.175
	17,5	105	702.176
	17,5	110	702.177
	17,5	115	702.178
	17,5	120	702.179
	17,5	125	702.180
	17,5	130	702.181
	17,5	135	702.182
	17,5	140	702.183

Continued next page - Suite page suivante





d	B	D	Ref.
69,85	20	80	702.125
	20	85	702.126
	20	90	702.127
	20	95	702.128
	20	100	702.129
	20	105	702.130
	20	110	702.131
	20	115	702.132
	20	120	702.133
	20	125	702.134
	20	130	702.135
	20	135	702.136
	20	140	702.137
75	18,5	90	702.190
	18,5	95	702.191
	18,5	100	702.192
	18,5	105	702.193
	18,5	110	702.194
	18,5	115	702.195
	18,5	120	702.196
	18,5	125	702.197
	18,5	130	702.198
	18,5	135	702.199
	18,5	140	702.200
80	18,5	90	702.210
	18,5	95	702.211
	18,5	100	702.212
	18,5	104	702.221
	18,5	105	702.213
	18,5	109,5	702.224
	18,5	110	702.214
	18,5	115	702.215
	18,5	120	702.216
	18,5	125	702.217
	18,5	130	702.218
	18,5	135	702.219
	18,5	140	702.220
	18,5	114	702.222

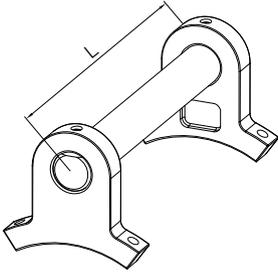

717.101/155

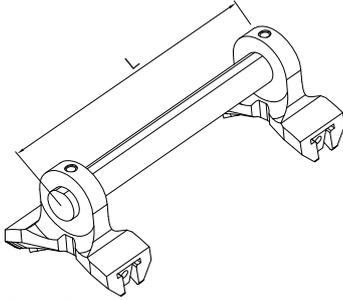

717.455

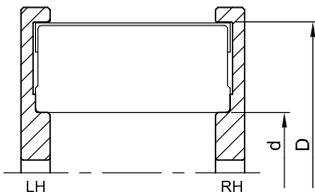

717.201/209

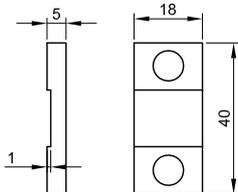

717.302

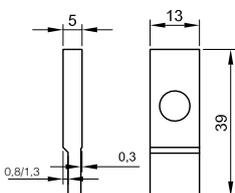

717.309/310

D	L	Ref.
125	120	717.101
	150	717.102
	180	717.103
	220	717.104
	240	717.105
140	120	717.151
	150	717.152
	180	717.153
	220	717.154
	240	717.155

Technical information: Adjustment gauge in steel body allowing tuning in different diameters and different body-cutting edges offsets (2 mm offsets in 125 and 140 mm diameters, 4 mm offsets in 125, 143 and 163 mm diameters).

Caractéristiques techniques: Calibreur avec corps en acier. Réglage sur différents diamètres et différents décalages corps-coupe (décalages de 2 mm pour diamètres de 125 mm et 140 mm, décalages de 4 mm pour diamètres de 125 mm, 143 mm et 163 mm).

L	Ref.
new 240	717.455

Technical information: Magnetic knife setting with micrometric adjustment, allowing tuning in different diameters and different body-cutting offsets.

Informations techniques: Calibreur magnétique avec réglage micrométrique, permettant de régler différents diamètres et différents décalages de coupe.

Ref.
new 717.600

Technical information: Gauge in light alloy body, sold in pairs (LH + RH).

Caractéristiques techniques: Calibreur avec corps en alliage léger, vendu par paires (LH+RH).

D	d	Ref.
125	30	717.201
	40	717.204
	50	717.207
140	30	717.202
	40	717.205
	50	717.208
150	30	717.203
	40	717.206
	50	717.209

B	H	S	a	Ref.
18	40	5	1	717.302
13	39	5	0,8-0,3	717.309
			1,3-0,3	717.310



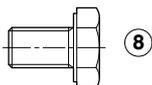
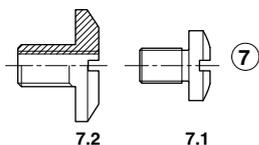
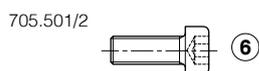
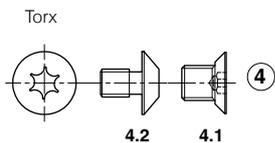
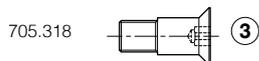
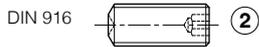
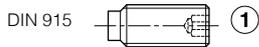

				Ref.
1- Hex socket setscrew - Vis sans tête a six pans DIN915				
M5x12	SW2,5			705.523
M5x16	SW2,5			705.582
M6x10	SW3			705.532
M6x12	SW3			705.533
M6x16	SW3			705.535
M8x12	SW4			705.541
M8x16	SW4			705.542
M8x20	SW4			705.544
M8x25	SW4			705.543
M10x16	SW5			705.551
M10x20	SW5			705.552
M10x25	SW5			705.553
M12x20	SW6			705.556
2- Slotted countersink screw - Vis a tête fraisée fendue DIN916				
M2,5x2,5	SW0,9			705.100
M4x4	SW2			705.101
M5x5	SW2,5			705.102
M5x8	SW2,5			705.511
M5x10	SW2,5			705.103
M6x6	SW3			705.583
3- Countersink with collar - Vis a tête a six pans				
M5x13,5				705.318
4- Screw Torx - Vis Torx				
M4 x3,2	4.1	T9		705.313
M4x4,2	4.1	T9		705.314
M5x6	4.1	T15		705.425
M3,5x7,5	4.2	T15		705.350
M3,5x4	4.2	T15		705.352
M4x4	4.2	T15		705.353
M4x6	4.2	T15		705.351
M4x9	4.2	T15		705.354
5- Special nut for groove - Écrou spécial pour porte-outils à rainer				
M4x1,6	ø9,9			709.128
M4x1,7	ø11,9			709.129
M4x2,3	ø11,9			709.127
6- Hex socket cap screw - Vis a tête cylindrique a six pans				
1/8"x3/32"				705.501
3/32"x5/64"				705.502
7- Special cylinder head screw - Vis spéciale tête cylindrique				
M5x7/Ø10	7.1			705.217
M5x7/Ø16	7.1			705.214
M6x8/Ø16	7.2			705.218
8- Special round head screw - Vis special a tête ronde				
M10x12				705.432
M10x17				705.433
1/4-19 BSPx15				705.435

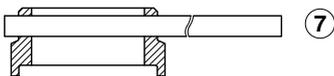
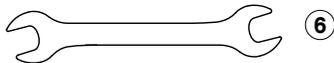
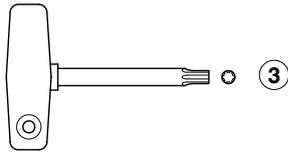
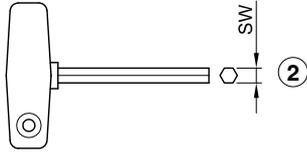
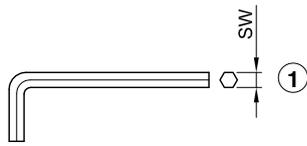

	SW	Ref.
1- Hex wrench - Clé six pans		
	3/32"	706.161
	5/64"	706.162
	1,3	706.149
	1,5	706.150
	2	706.151
	2,5	706.152
	3	706.153
	4	706.154
	5	706.155
	6	706.156
2- Hex wrench - Clé six pans		
	2,5	706.102
	3	706.103
	4	706.104
	5	706.105
	6	706.106
	10	706.107
3- Torx wrench - Clé Torx		
	T9	706.303
	T15	706.304
	T20	706.305
4- Torx wrench - Clé Torx		
	T9	706.301
	T15	706.302
5- Hook wrench - Clés plates		
	40/42 M30x1,5	706.500
	45/50 M40x1,5	706.504
	58/62 M48x2	706.503
	68/75 M50x1,5	706.501
	80/90 M60x2	706.502
6- Open-ended spanner - Clés à ergot		
	14/15	706.401
7- Special wrench - Clé special		
	M50x1,5	706.601
	M60x2	706.602



	Ref.
new Torque spanner - Llave de torsión	60-300 Nm 706.710

Spare parts - Pièces de rechange

		Nm	Ref.
Wrench - Clé	ER32 M40x1,5	60	706.710.06
	ER40 M50x1,5	80	706.710.08
	462E M48x2	100	706.710.10



707

Clamping wedge Contrefers

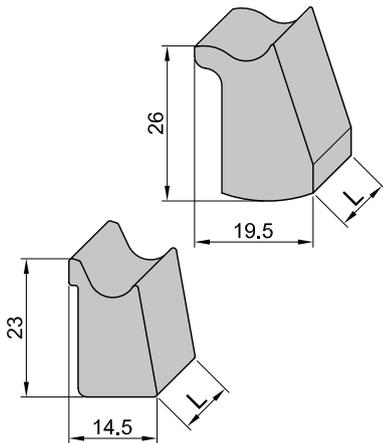

Clamping wedge under request.
Contrefers sur demande.

		Ref.
Lx 14,5x23	Mida	707.450
Lx 19,5x26	Pinheiro / Frama	707.451

A431

Mounting device Dispositifs de montage

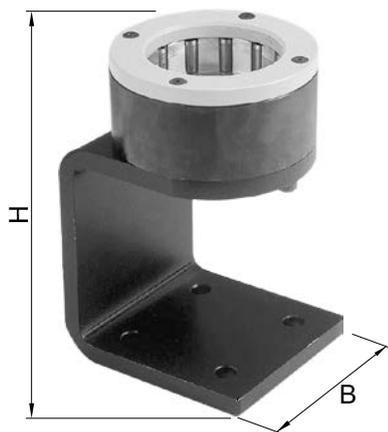

Technical information: Mounting device with bidirectional roller bearings system offering the highest protection to the collet holder cone. The mounting device must be fixed to a bench or a tool cart.

Caractéristiques Techniques: Dispositif de montage avec roulements spéciaux pour porte-pinces et arbres porte-fraises, ce qui garantit la protection maximum du mandrin. Le dispositif de montage doit être fixé sur un plan de travail.

	D	BxH	Ref.
ISO30	46	100X160	A431.300.046.00
ISO30	49	100x160	A431.300.049.00
SK30	50	100x160	A431.300.050.00
BT35	53	100x160	A431.300.053.00
SK40 / HSK 63F	63	100x160	A431.300.063.00
HSK85 WE	85	150x230	A431.300.085.00



FREZITE – Ferramentas de Corte, SA

Head Office / Siége Social: Rua do Vau, 173, Apartado 134, 4786-909 Trofa, PORTUGAL
Tel: +351 252 400 360 | Fax: +351 252 417 254 | E-mail: info@frezite.com

Find your local partner at: / Retrouvez votre distributeur sur:

www.frezite.com

FREZITE Group